

# INSTRUKCJA MONTAŻU

FITTING-UP INSTRUCTION / AUFBAUANLEITUNG

MONTÁŽNÍ NÁVOD / MONTÁŽNY NÁVOD / SZERELÉSI UTASÍTÁS

ARDILA

ARD-KO150

EBRO

EBR-KO150

# restol

Producent:

**PPIH RESTOL Sp. z o.o.**

36-055 Bratkowice 6

[www.restol.com.pl](http://www.restol.com.pl)

[info@restol.com.pl](mailto:info@restol.com.pl)

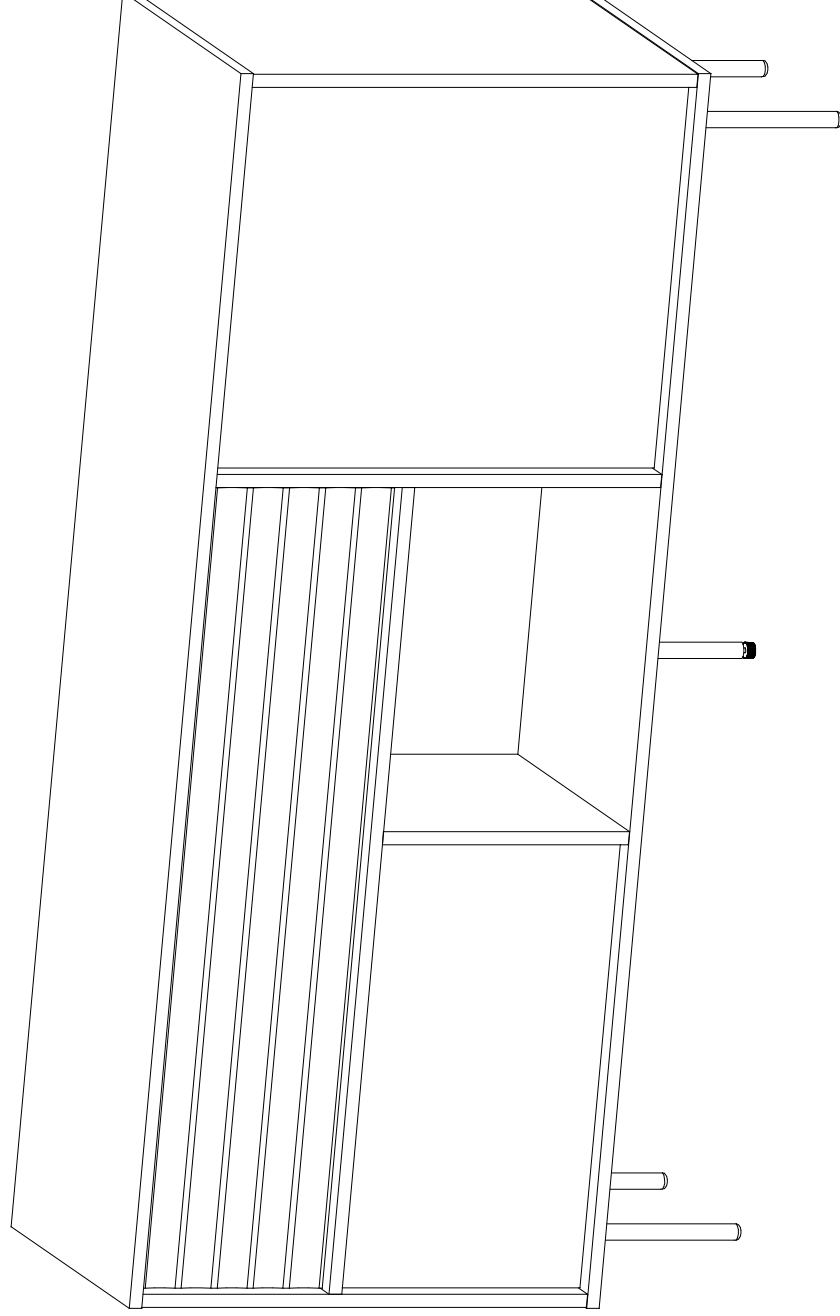

szerokość / wysokość / głębokość: 1515 / 800 / 400

#### WSKAZÓWKA na temat pielęgnacji mebla.

Czyścić elementy wilgotną szmatką lub papierowym ręcznikiem.  
Nie używać chemicznych środków czyszczących.

#### DIRECTION for the furniture cleaning.

Clean elements with the moist wiper or soft paper towel. Do not use any detergents.

#### Pflegehinweis.

Nur mit feuchtem Lappen, bzw Papiertuch Ihre Möbel reinigen.  
Keine chemischen Waschnittel einsetzen.

#### POKYN pro ošetřování nábytku.

Díly čistit vlhkým hadříkem nebo papírovou utěrkou.  
Nepoužívat chemické čisticí prostředky.

#### POKYNY k údržbe nábytku.

Prvky nábytku čistit vlhkou handričkou alebo papierovou utierkou.  
Nepoužívať chemické čistiace prostriedky.

#### UTMATATÓ a bútor ápolására.

Az elemeket nedves ronggyal vagy papírtörülközővel tisztítani.  
Vegyí tisztítószeret nem használni.

Gwarancja dostępna pod linkiem:

Guarantee available at:

Die Garantie ist unter dem Link:

Záruka je k dispozíci na následujícím odkazu:

Záruka k dispozícii pod odkazom:

Link a jótálláshoz :

[www.sklep.restol.com.pl/  
upload/gwarancja.pdf](http://www.sklep.restol.com.pl/upload/gwarancja.pdf)

???

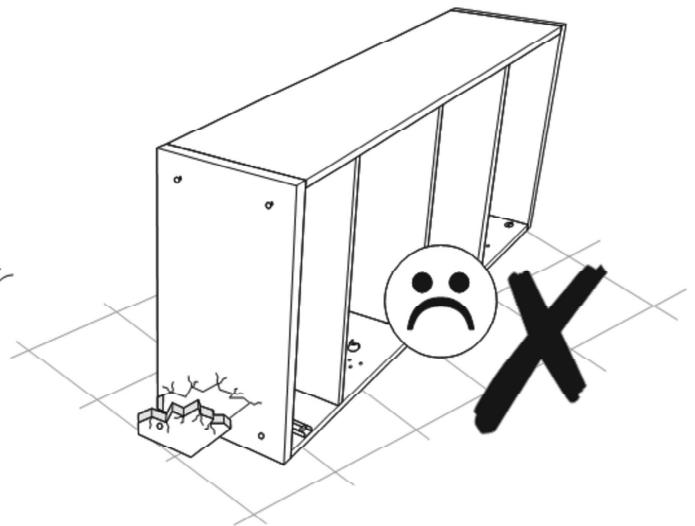
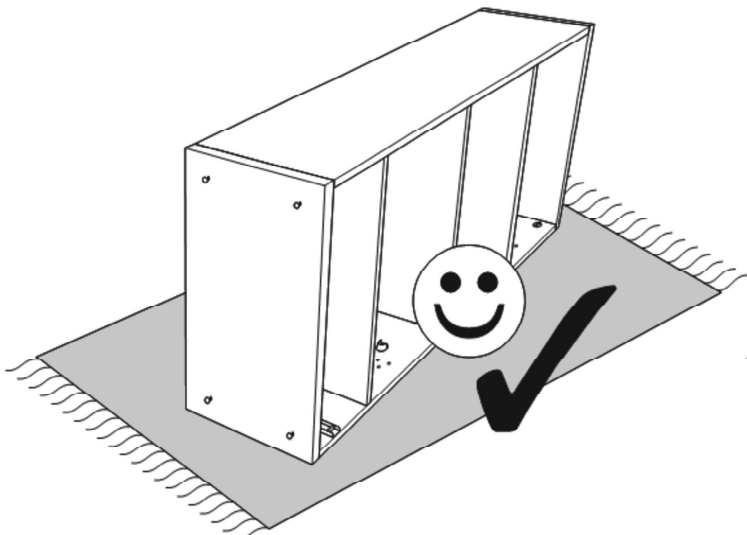
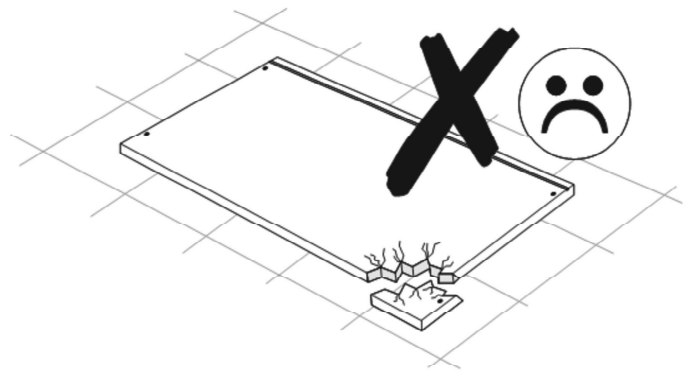
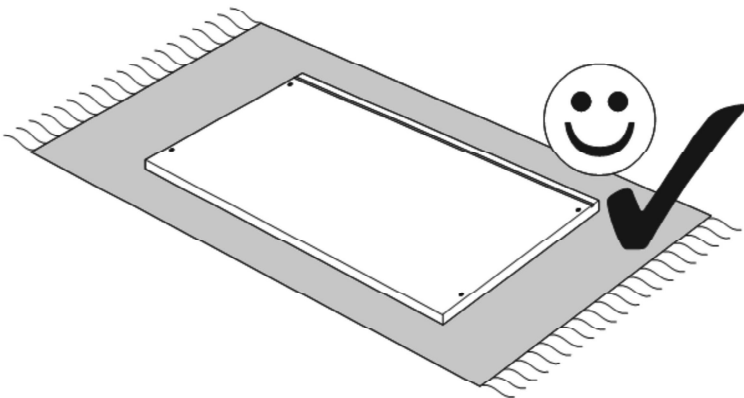
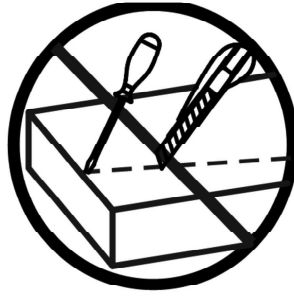
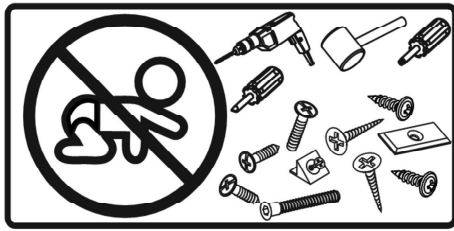
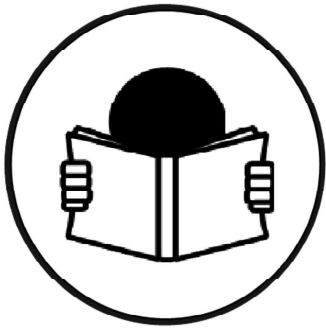

Do montázu potřebné sa:  
 You need for fitting-up:  
 Zur Montage werden Sie brauchen:  
 K montáži jsou potřebné:  
 Na montáž potrebujúce:  
 A szereléshez szükséges:

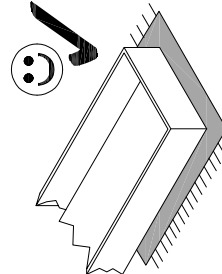
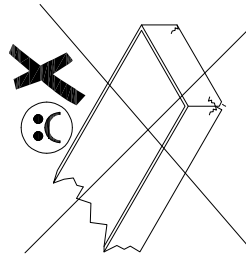
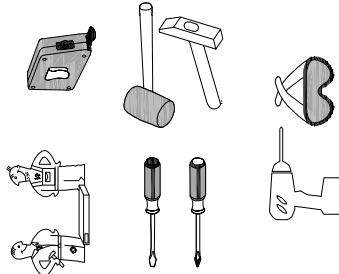

REP	DIM	QTY	PACK
1	568 x 399 x 16	1	2/2
2	568 x 399 x 16	1	2/2
3	1515 x 400 x 16	1	1/2
4	1515 x 400 x 16	1	1/2
5	314 x 379 x 16	1	2/2
6	568 x 379 x 16	1	2/2
7	990 x 379 x 16	1	1/2
8	474 x 340 x 16	1	2/2
9	544 x 306 x 16	1	2/2
10	560 x 467 x 16	1	2/2
11	982 x 230 x 18	1	1/2
12	1495 x 291 + 291 x 3	1	1/2
14	274 x 160 x 16	1	2/2
15	274 x 160 x 16	1	2/2
16	535 x 152 x 16	1	2/2
17	503 x 274 x 16	1	1/2

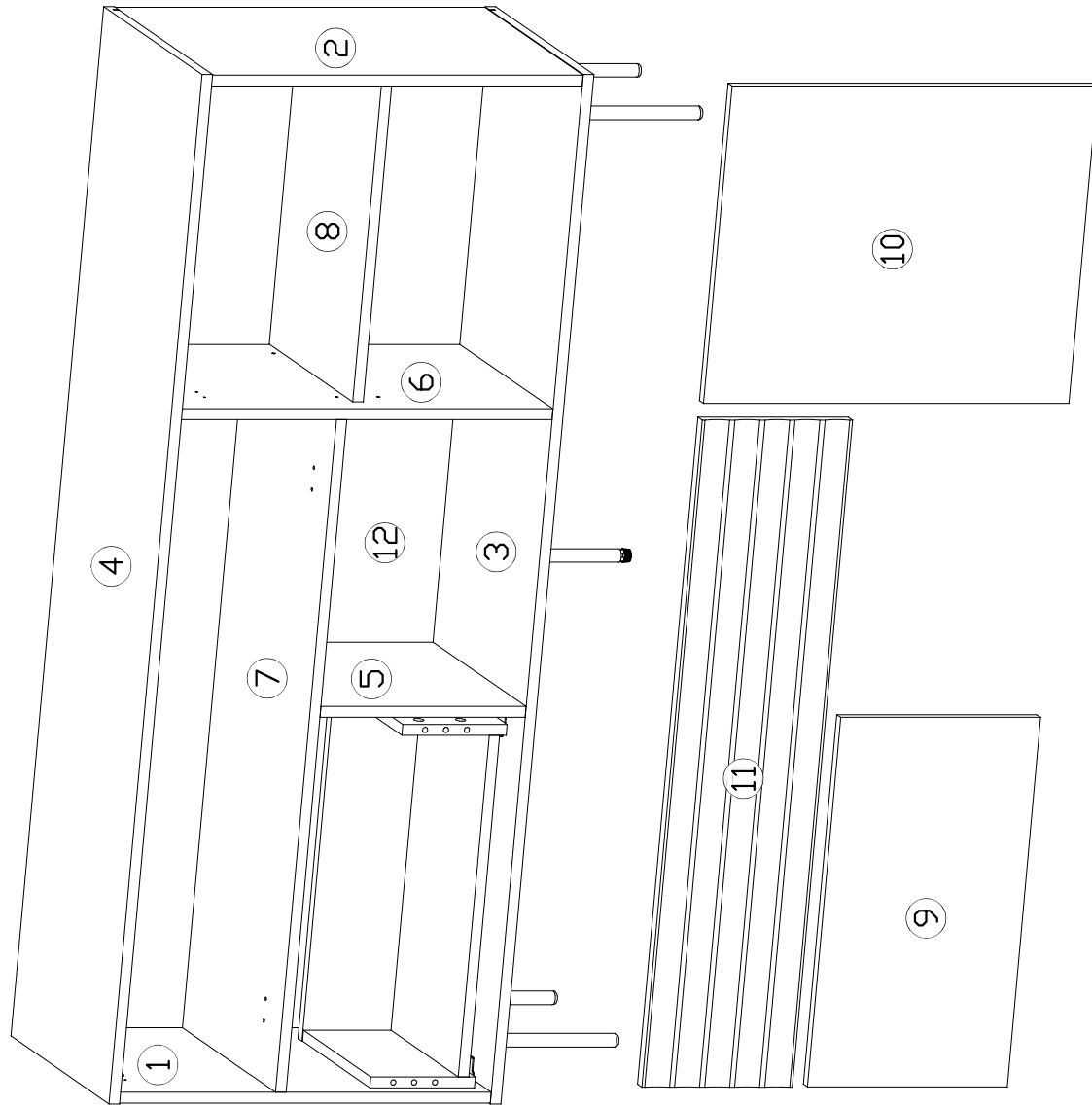

### BAG 1

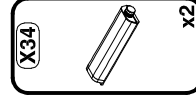
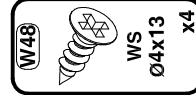
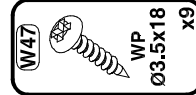
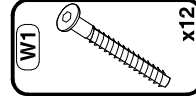
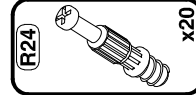
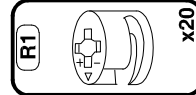
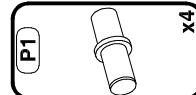
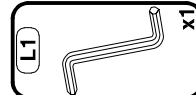
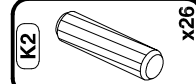
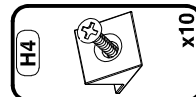

### BAG 2

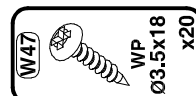
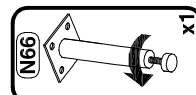
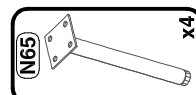

### BAG 3

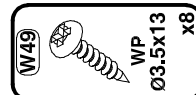
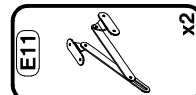

### BAG 4



### BAG 5

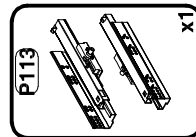

### BAG 6

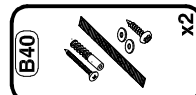

1

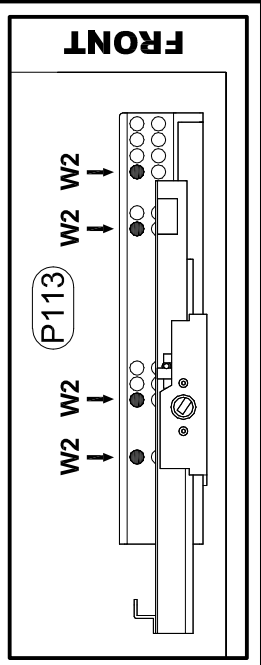
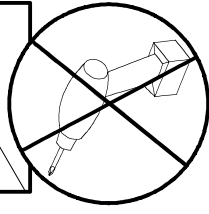
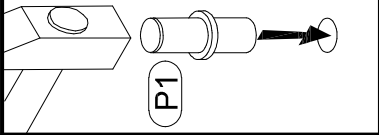
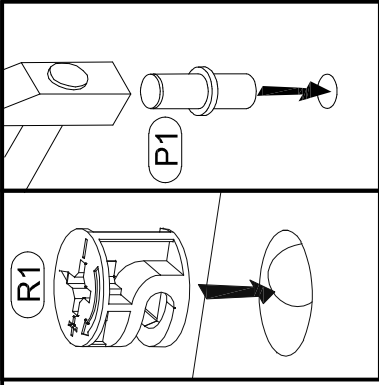
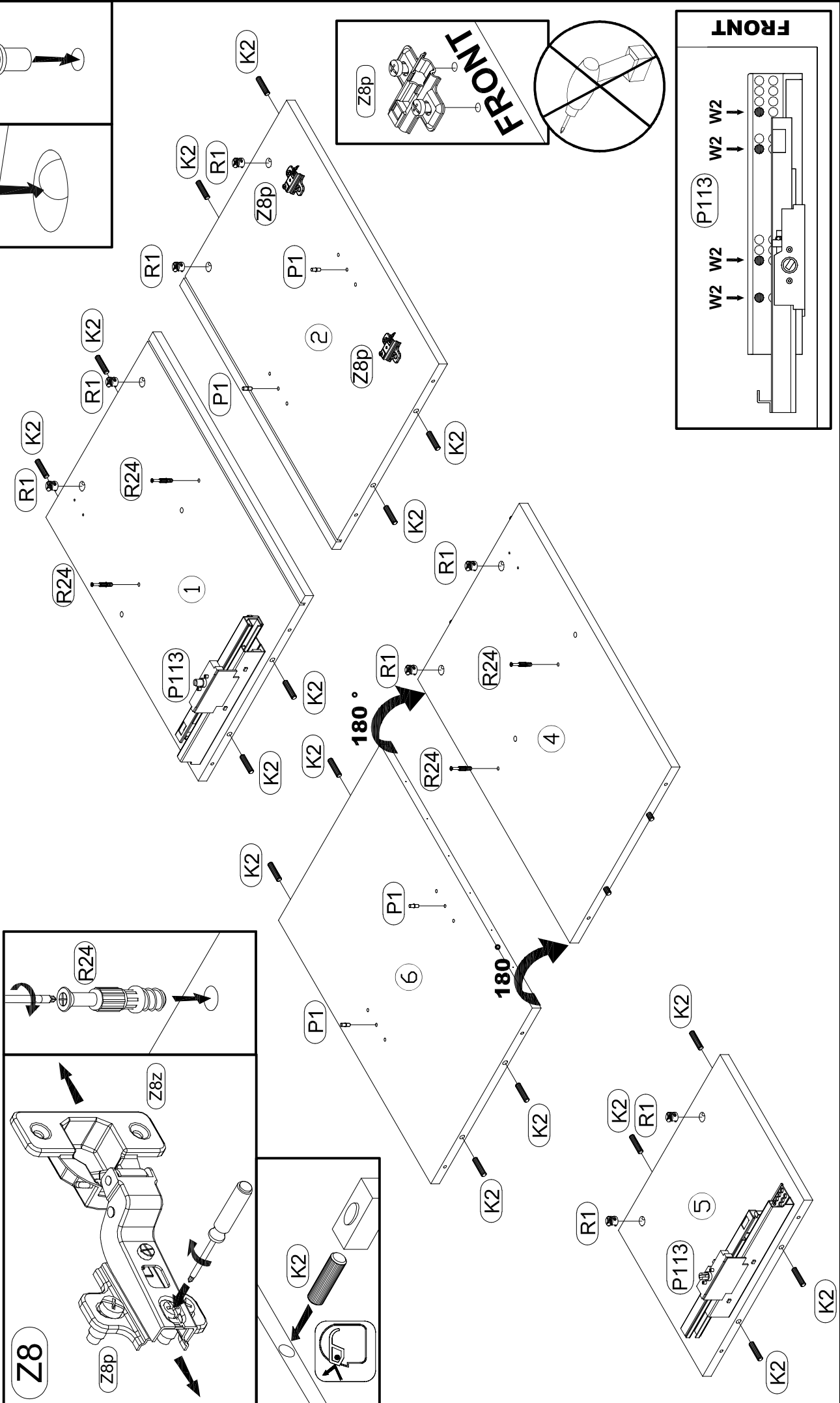
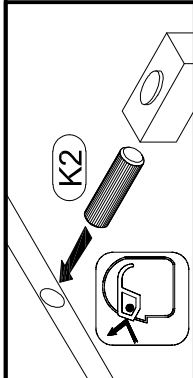
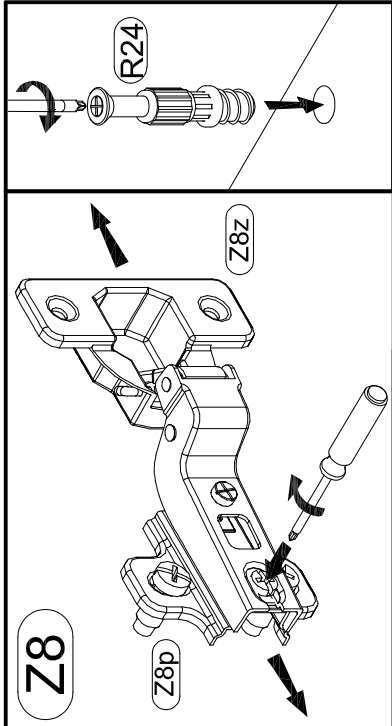

2

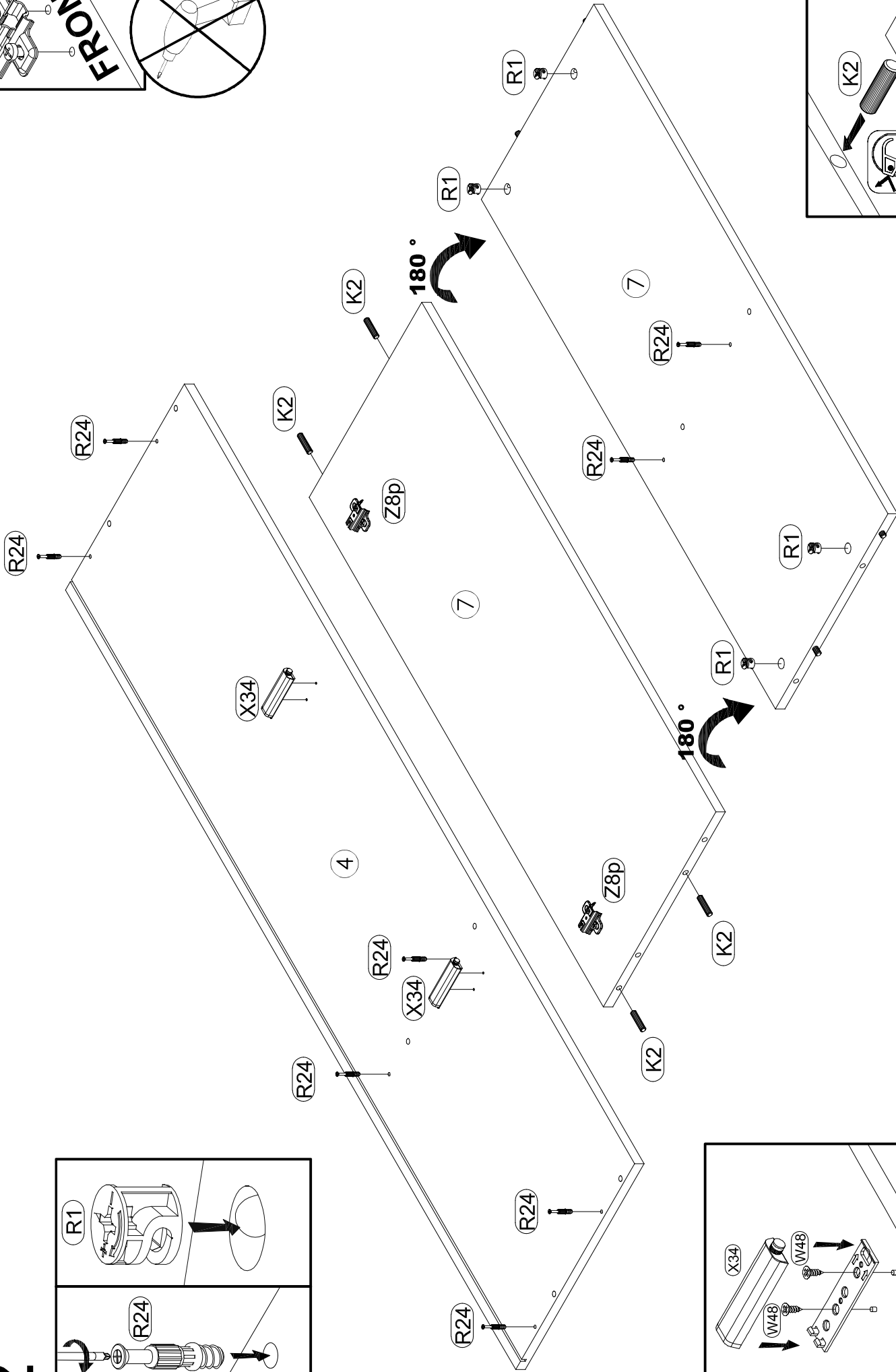
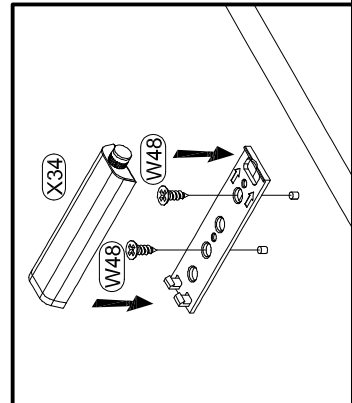
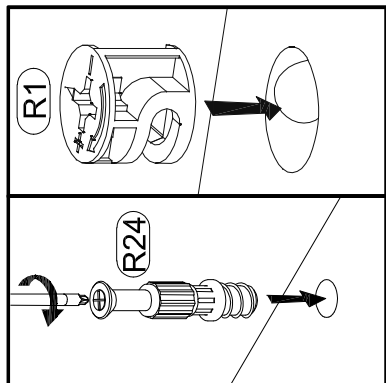

Z8p

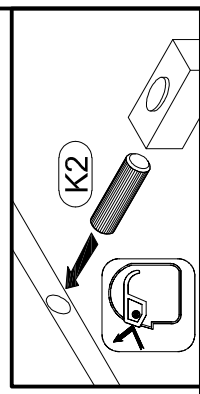
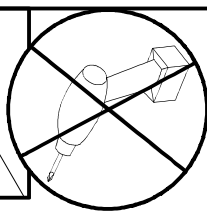
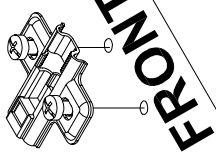

# 3

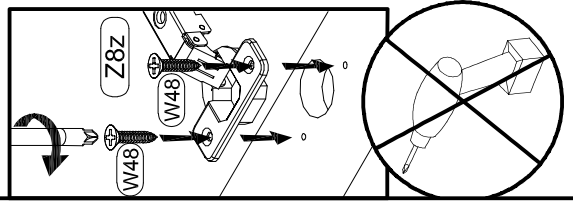
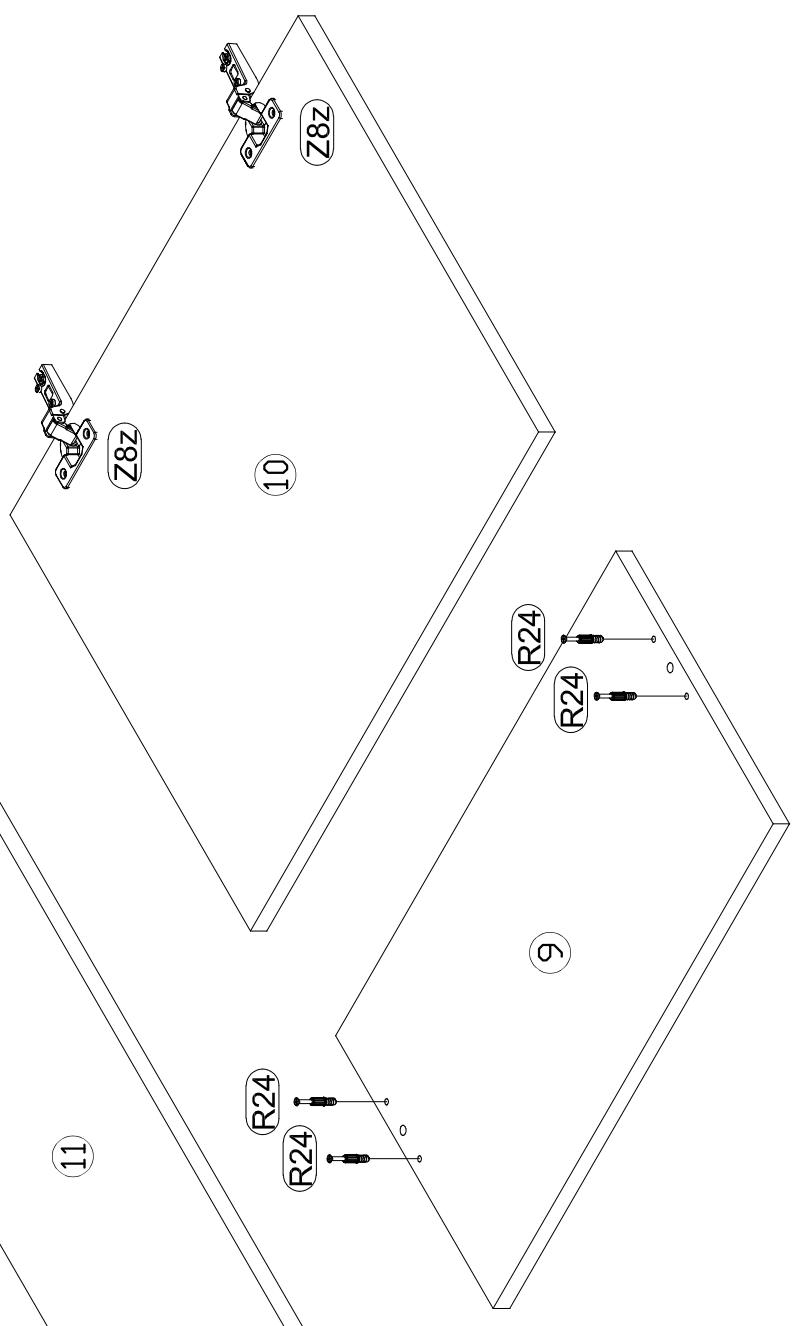
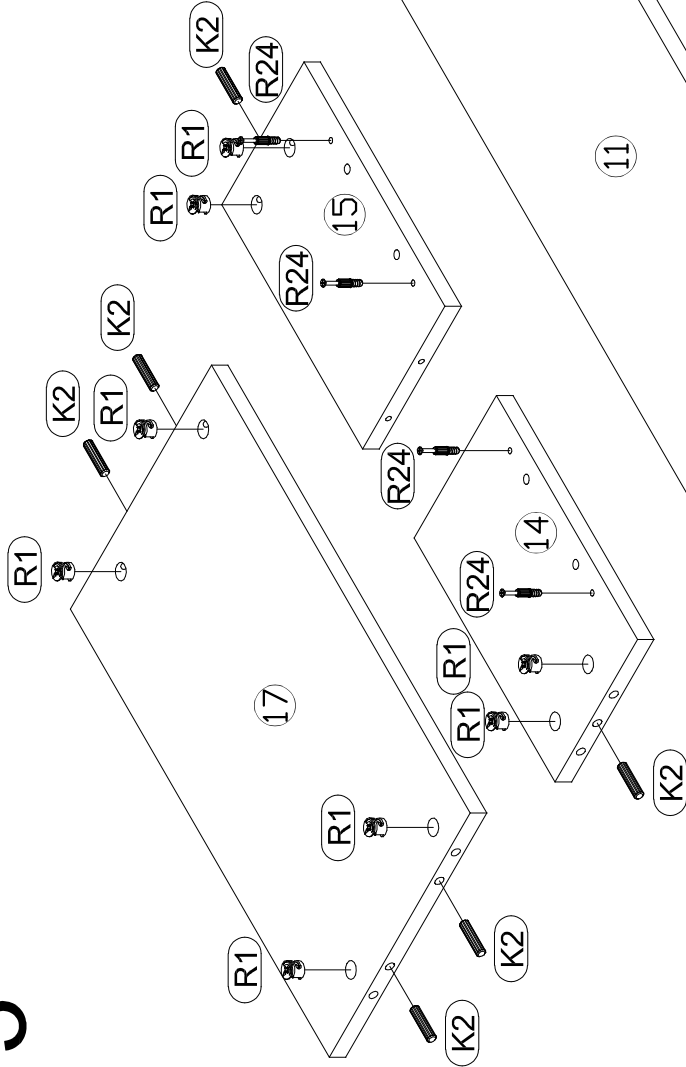
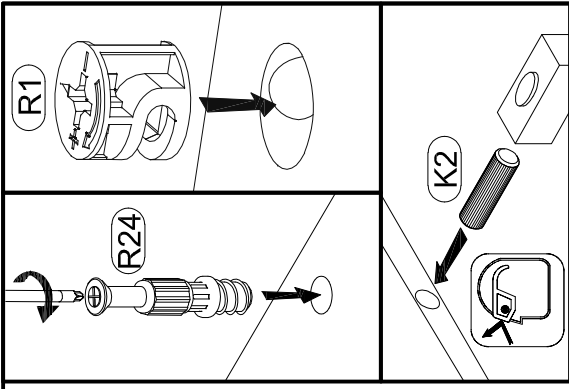

4

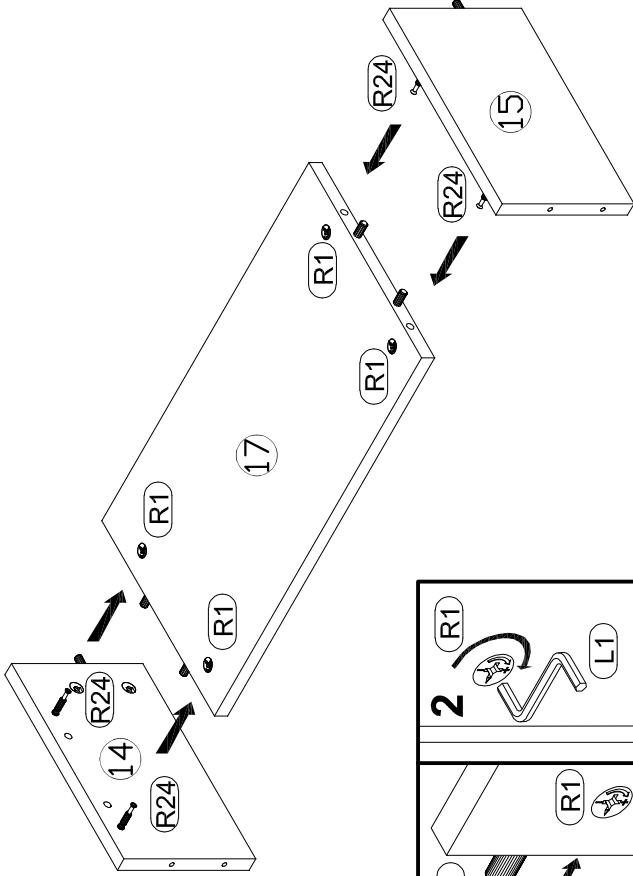

6

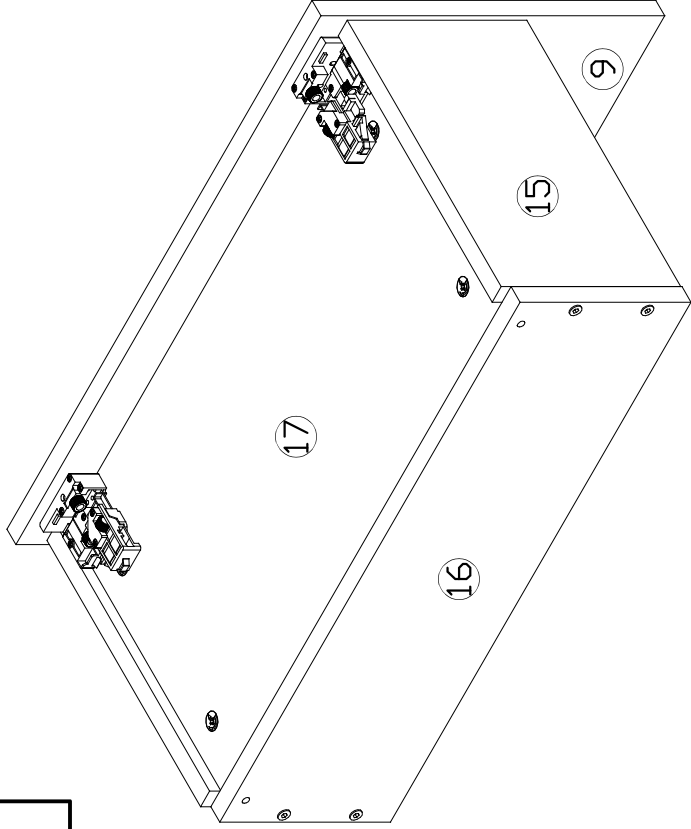

1

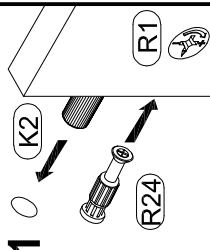

2

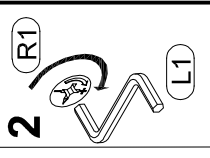

5

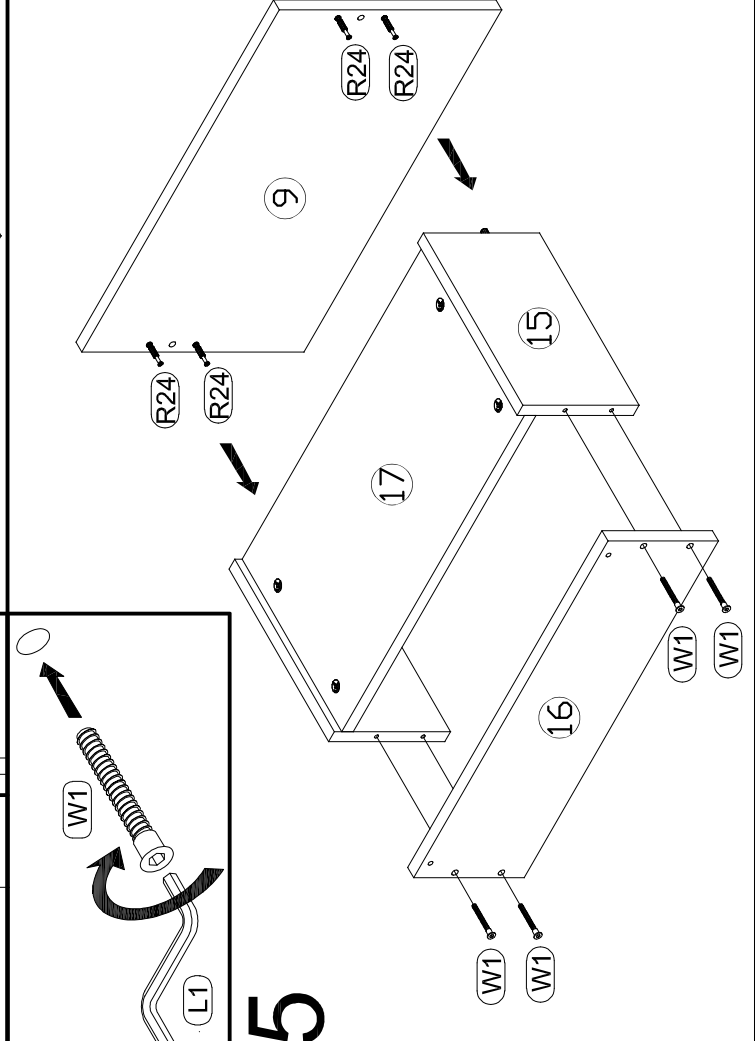

1

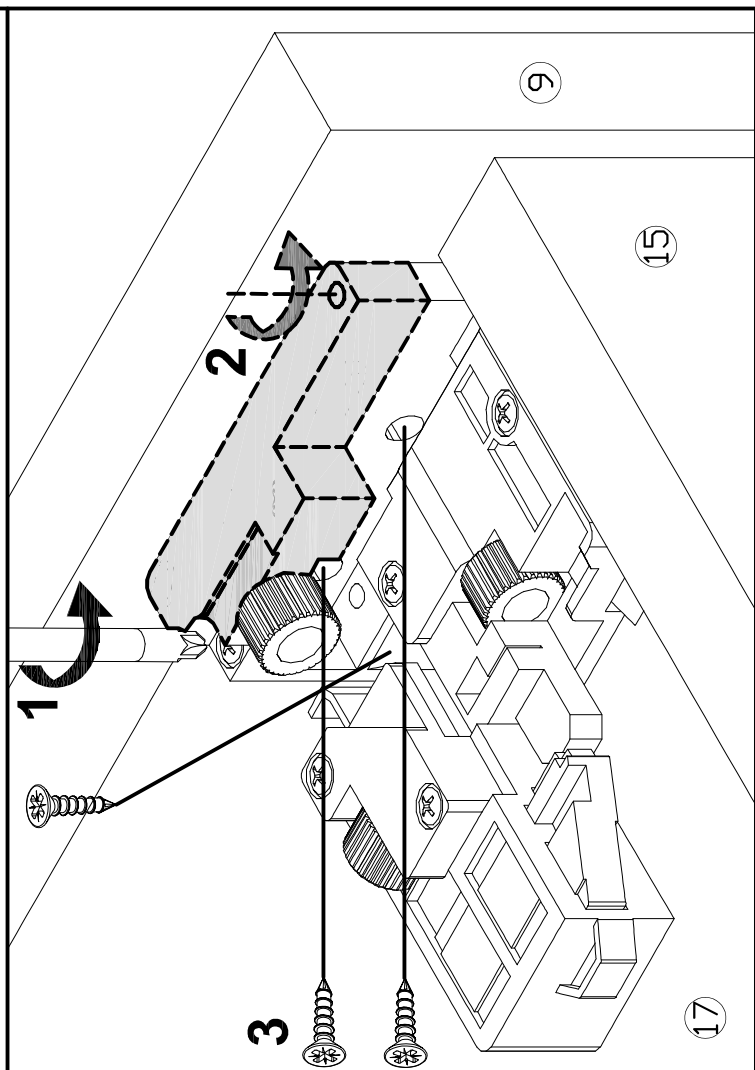

3

2

9

15

17

9

17

15

16

W1

W1

R24

R24

R24

R24

17

16

15

9

# 7

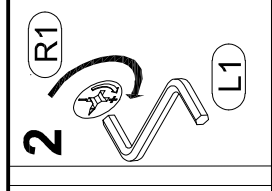
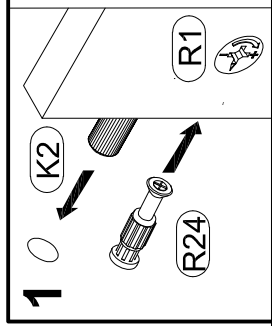
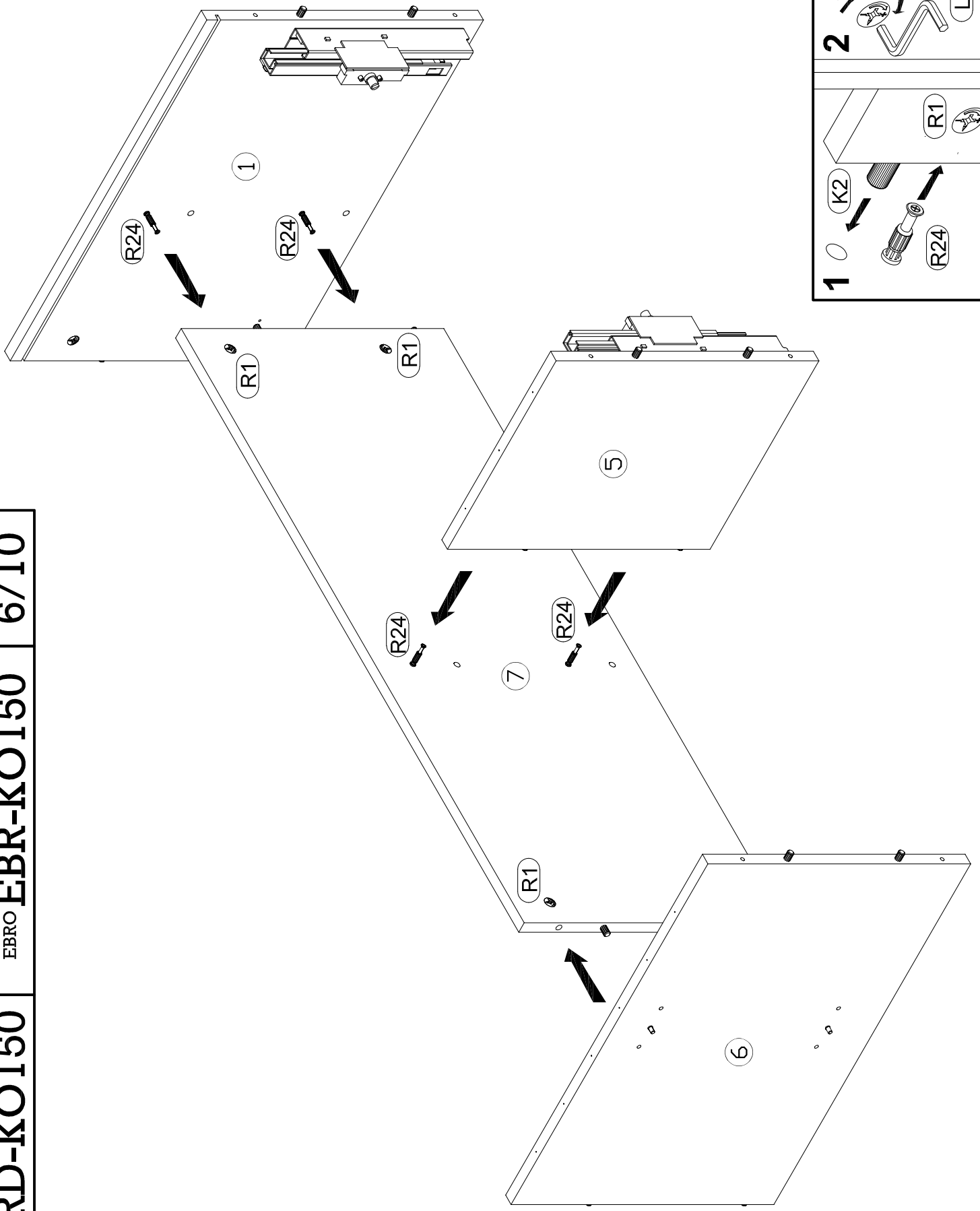

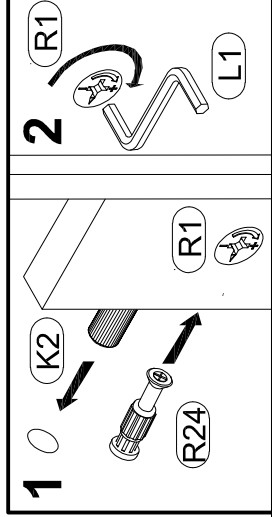
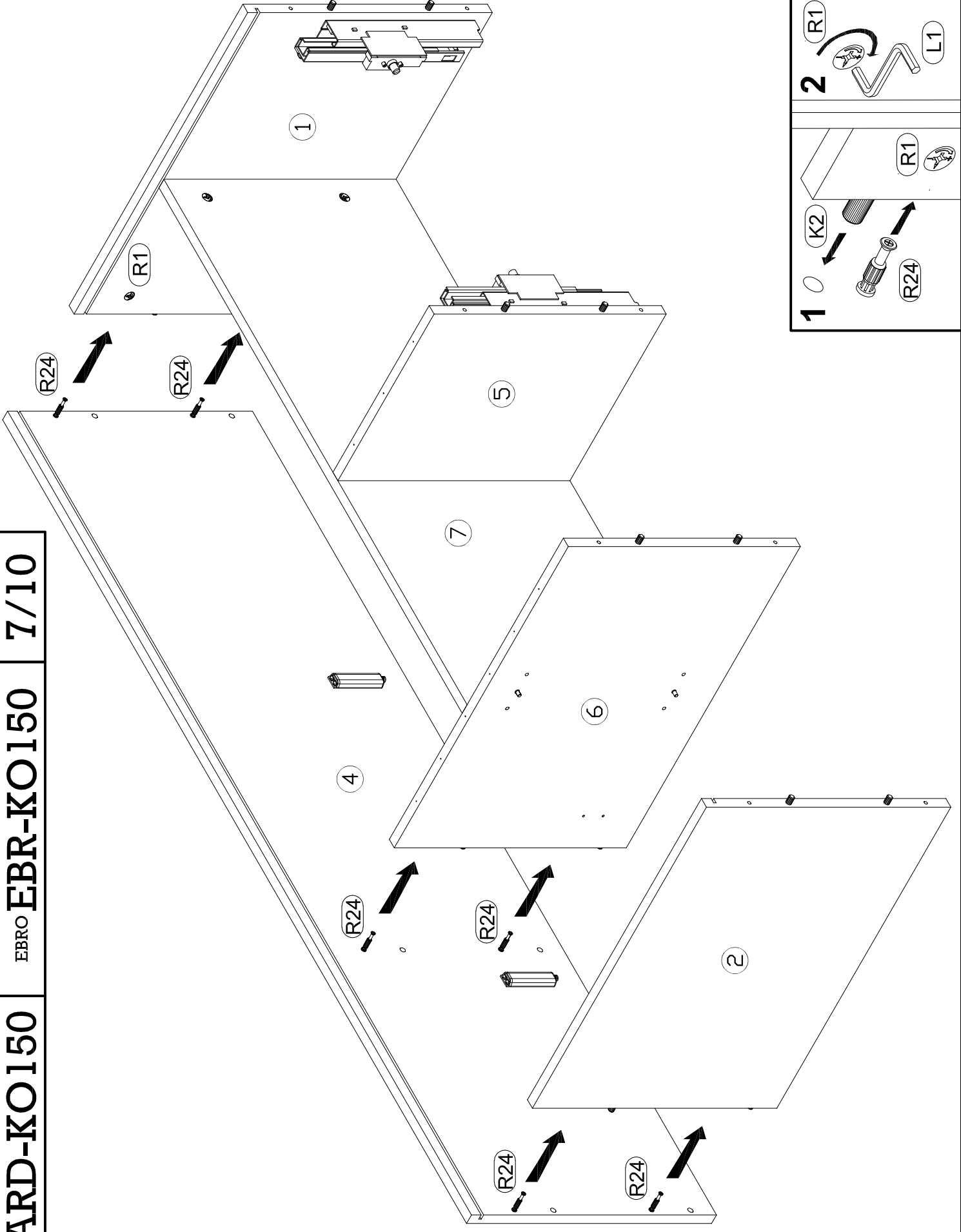

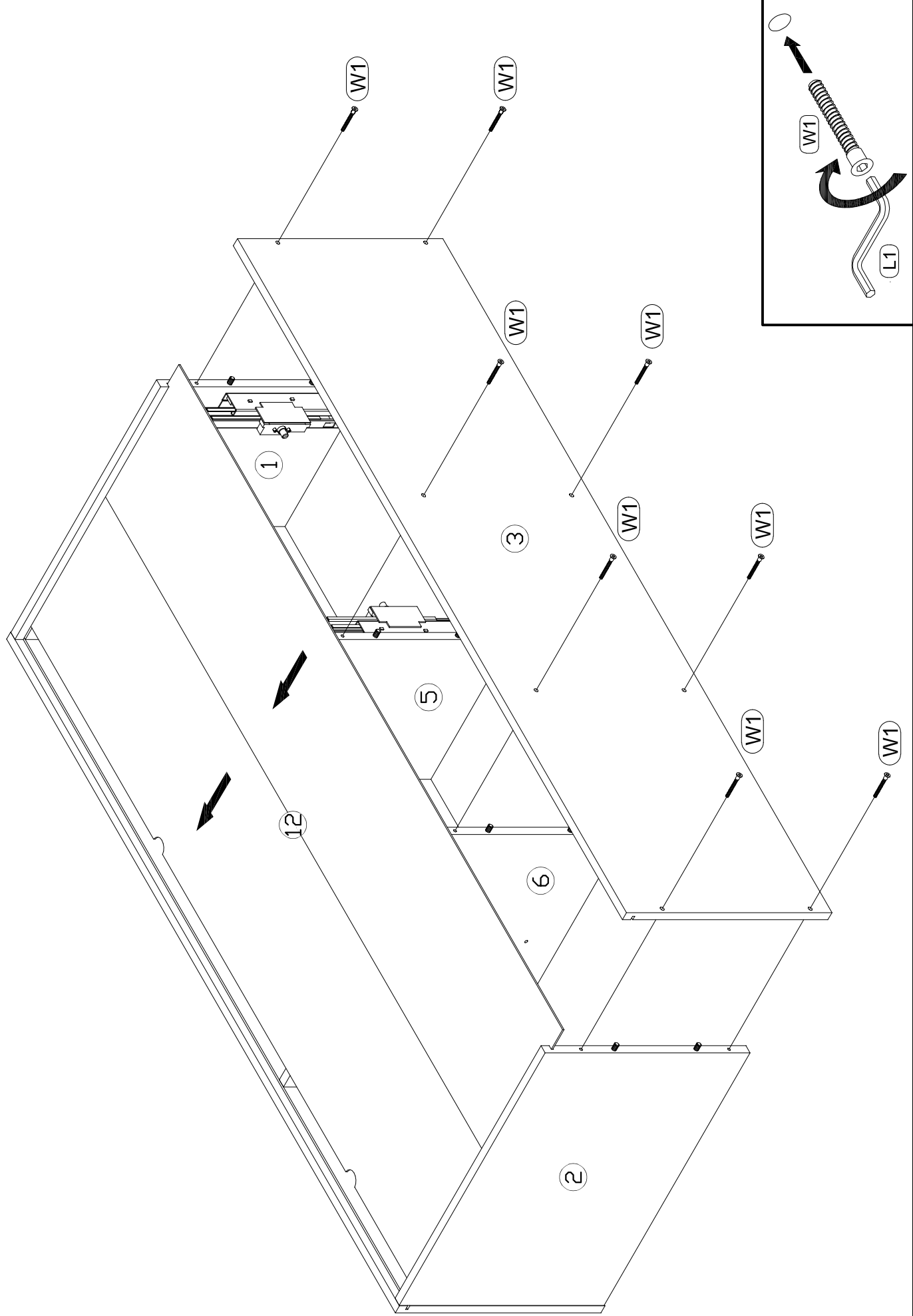

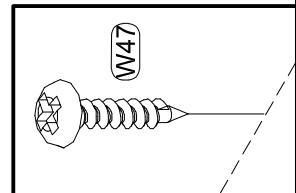
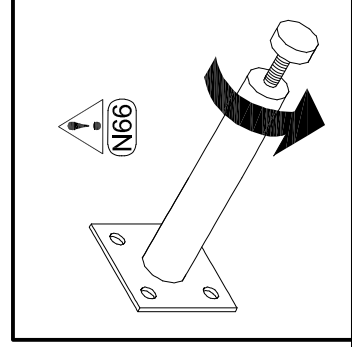
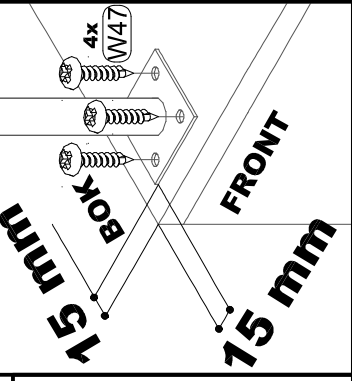
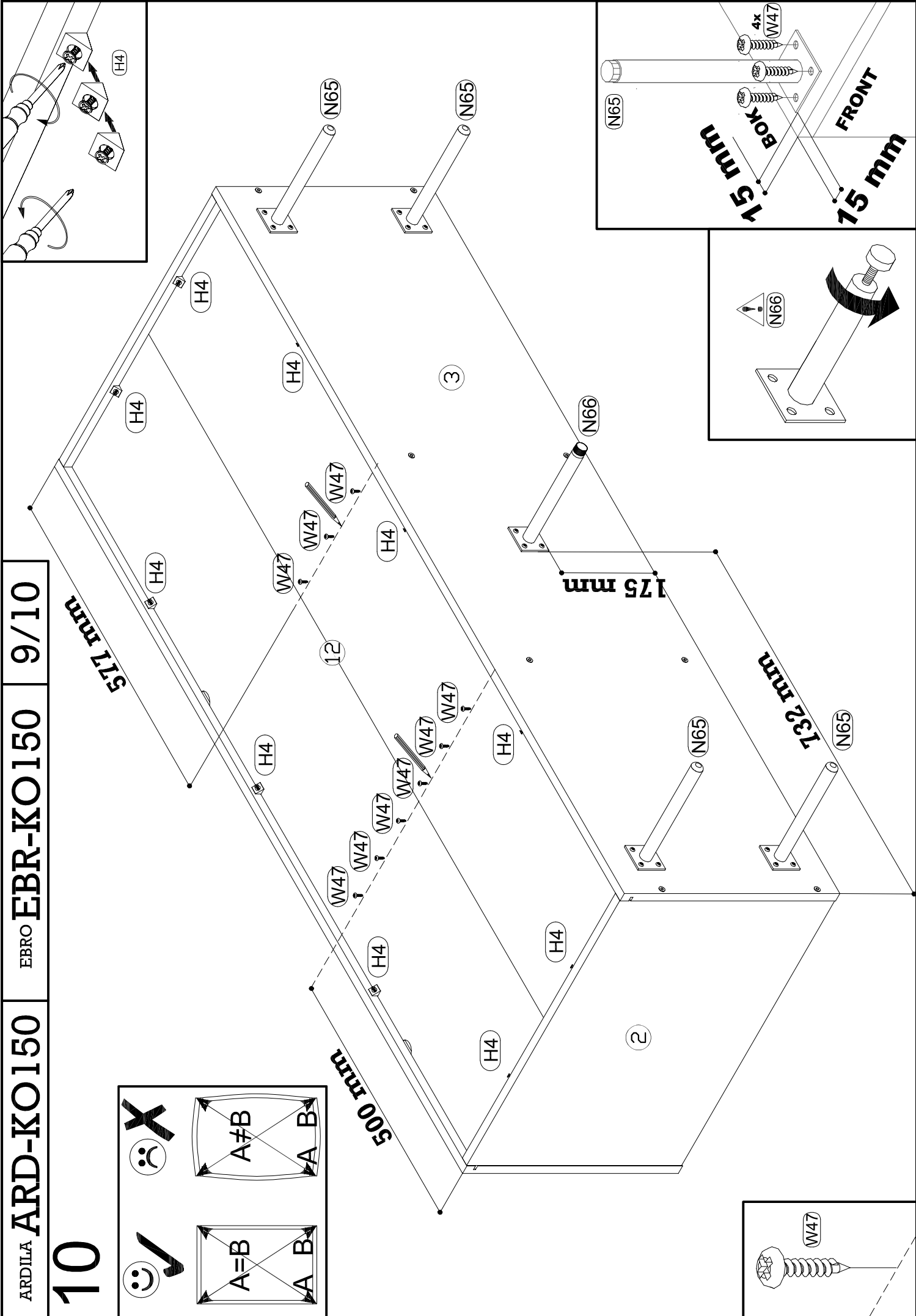
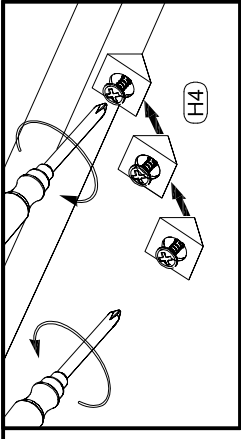
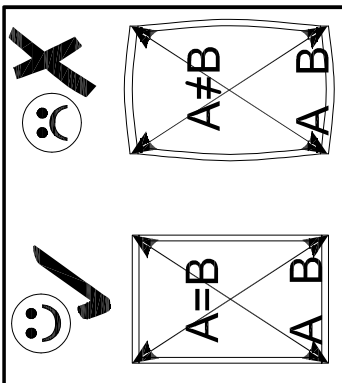

11

